

















CHOOSE THE RIGHT LYSAGHT® METAL ROOFING AND WALLING PROFILES FOR YOUR DESIGN

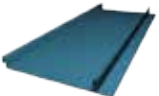

LYSAGHT® Profiles	BMT	Steel Grade	Mass (kg/m ²)	Cover Width	Rib Depth	Min Roof Pitch	Max Recommended Support Spacing ^[1]								
							Roofing					Walling			
							Single	End	Internal	Unstiffened Overhang	Stiffened Overhang ^[2]	Single	End	Internal	Overhang
							mm	mm	mm	mm	mm	mm	mm	mm	mm
KLIP-LOK OPTIMA™ 	0.42	G550	4.39	980	43	2°	850	1050	1450	150	450	1900	1900	3075	150
	0.48	G550	4.98	980	43	2°	1000	1200	2200	200	500	2400	2500	3600	200
	0.60	G550	6.15	980	43	2°	1500	1500	3500	250	550	2500	2700	3600	250
SPANDEK OPTIMA™ 	0.42	G550	4.60	935	24	3°	1500	2100	2300	200	450	2200	3100	3300	150
	0.48	G550	5.21	935	24	3°	2200	2400	3300	250	500	2300	3200	3300	150
TRIMDEK OPTIMA™ 	0.42	G550	4.24	1015	28.5	3°	1200	1900	2500	150	250	2200	2500	3300	150
	0.48	G550	4.80	1015	28.5	3°	1600	2100	3000	150	250	2300	2700	3300	150
KLIP-LOK® 406 	0.48	G550	5.85	406	41	2°	1800	2400	3000	200	600	2400	2400	2400	400
	0.60	G550	7.12	406	41	2°	2300	2700	3600	300	900	2700	3000	3000	600
SPANDEK® 	0.42	G550	4.81	700	24	3°	1300	1800	2400	300	600	2500	3000	3300	300
	0.48	G550	5.45	700	24	3°	2000	2200	3000	400	700	3000	3000	3300	400

LYSAGHT® Profiles	BMT	Steel Grade	Mass (kg/m ²)	Cover Width	Rib Depth	Min Roof Pitch	Max Recommended Support Spacing ^[1]								
							Roofing					Walling			
							Single	End	Internal	Unstiffened Overhang	Stiffened Overhang ^[2]	Single	End	Internal	Overhang
							mm	mm	mm	mm	mm	mm	mm	mm	mm
	mm	MPa	COLORBOND® Steel	mm	mm	Degree	mm	mm	mm	mm	mm	mm	mm	mm	mm
TRIMDEK® 	0.42	G550	4.43	760	29	3°	1100	1300	1900	150	300	2400	3000	3000	150
	0.48	G550	5.02	760	29	3°	1600	1850	2600	200	350	2700	3000	3000	200
HR-29® OPTIMA 	0.42	G550	4.43	970	38	2°	-	-	-	-	-	-	-	-	-
	0.75	G550	7.69	970	38	2°	-	-	-	-	-	-	-	-	-
HR-29® 	0.42	G550	4.54	730	38	2°	-	1700	2200	150	300	3600	3900	4500	-
	0.75	G550	7.88	730	38	2°	2100	3800	4600	250	400	3600	3900	4500	-
CUSTOM ORB® 	0.42	G550	4.35	762	16	5°	700	900	1200	200	300	1800	2500	2700	200
	0.48	G550	4.93	762	16	5°	800	1300	1700	250	350	1800	2700	2700	250
CUSTOM BLUE ORB® 	0.60	G300	6.09	762	16	5°	1600	1600	1800	200	300	2400	3000	3300	200
	0.80	G300	8.03	762	16	5°	1800	1800	2600	400	600	2400	3200	3600	400

LYSAGHT® Profiles	BMT	Steel Grade	Mass (kg/m ²)	Cover Width	Rib Depth	Min Roof Pitch	Max Recommended Support Spacing ^[1]								
							Roofing					Walling			
							Single	End	Internal	Unstiffened Overhang	Stiffened Overhang ^[2]	Single	End	Internal	Overhang
							mm	mm	mm	mm	mm	mm	mm	mm	mm
STYLEDEK® OPTIMA 	0.42	G300	4.15	1050	35	15°	-	300	600	-	-	-	-	-	-
BORNEO TILE® 	0.42	G300	5.04	420	16	18°	-	-	-	-	-	-	-	-	-
360 SEAM® ^[3] 	0.55	G300	5.21	521	25	3°	-	-	-	-	-	-	-	-	-
			5.48	495	38	3°									
SELECT SEAM II® ^[3] 	0.55	G300	5.25	517	25	7.5°	-	-	-	-	-	-	-	-	-
ZIPDEK® ^[3] 	0.55	G300	6.59	400	65	1°	-	1800	2050	-	-	-	2050	2500	-

LYSAGHT® Profiles	BMT	Steel Grade	Mass (kg/m ²)	Cover Width	Rib Depth	Min Roof Pitch	Max Recommended Support Spacing ^[1]								
							Roofing					Walling			
							Single	End	Internal	Unstiffened Overhang	Stiffened Overhang ^[2]	Single	End	Internal	Overhang
							mm	mm	mm	mm	mm	mm	mm	mm	mm
	mm	MPa	COLORBOND® Steel	mm	mm	Degree	mm	mm	mm	mm	mm	mm	mm	mm	mm
X-VERGE™ 	0.55	G300	6.08	200	25	-	-	-	-	-	-	1200	1200	1500	100
			6.03	300	25	-	-	-	-	-	-	1200	1200	1500	100
MULTICLAD® OPTIMA 	0.42	G550	3.87	1110	12	-	-	-	-	-	-	1200	1600	10	150

^[1] See appendix 1 for spacing definitions.

^[2] See appendix 2 for explanation of 'stiffened'.

^[3] The max support spacing is not applicable to Standing Seam roofing panels due to the profiles are intended for use as outer cladding only.

Appendix 1: Spacing Definations

Roofing & Walling Profiles

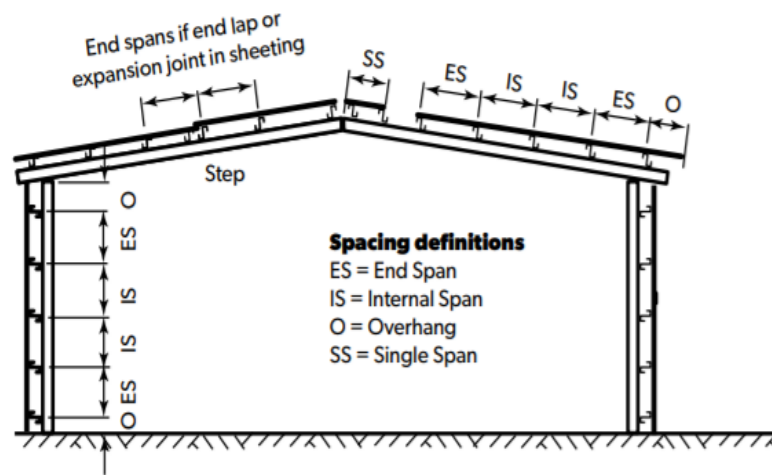

Walling Profiles Only

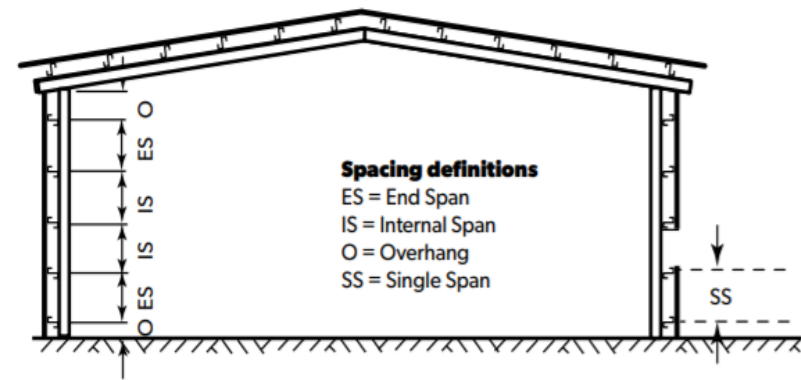

Appendix 2: Roof overhang with edge stiffener

For the stiffened overhangs listed in the table, you need to stiffen the gutter ends of the roofing. The gutter fixed through the return lip to the underside of roofing at 200mm centres will provide the required stiffening. Alternatively, you can use a 50 x 50 x 1.2mm ZINCALUME® / COLORBOND® steel angle fixed at 200mm centres to the underside of the roofing about 50mm from the end.

Methods of stiffening roof overhangs.

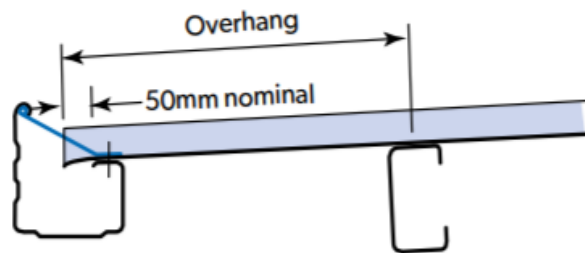

Sheerline gutter fixed to underside of roofing
(200mm centres)

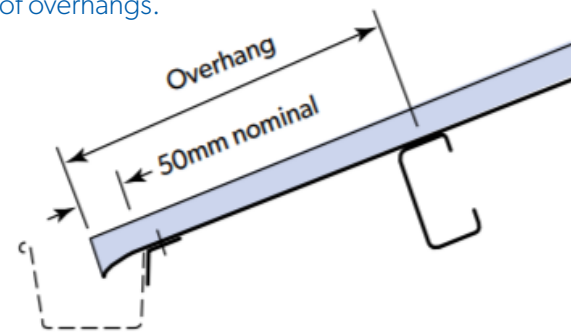

Galvanised or ZINCALUME® / COLORBOND® steel angle
50x50x1.2mm fixed to underside of roofing (200mm centres).
Gutter may be fixed to angle.

For more information, please contact us:



PEN. MALAYSIA +03-5520-6600 | **SARAWAK** +6082-333-621 | **SABAH** +6088-445-161 | **BRUNEI** +673-244-7155 | **SINGAPORE** +65-6264-1577
Email : lysaght.malaysia@bluescope.com | **Web** : www.lysaghtasean.com | **Facebook** : www.facebook.com/lysaghtMYBN